

# TEST REPORT

## CERTIFICATE OF CONFORMITY

**Standards:** 47 CFR FCC Part 15, Subpart B, Class A  
ANSI C63.4:2014

**Report No.:** FDBDBO-WTW-P21090210

**Model No.:** SPC-2845

**Series Model:** SPC-2XXXXXXXXXXXXXXXXX  
("X" can be 0-9, A-Z or blank for marketing purpose)

**Received Date:** 2021/9/6

**Test Date:** 2021/9/17 ~ 2021/9/28

**Issued Date:** 2021/10/15

**Applicant:** Vecow Co., Ltd.

**Address:** 3F., No.10, Jiankang Rd., Zhonghe Dist., New Taipei City 23586, Taiwan

**Issued By:** Bureau Veritas Consumer Products Services (H.K.) Ltd., Taoyuan Branch Lin Kou Laboratories

**Lab Address:** No. 47-2, 14th Ling, Chia Pau Vil., Lin Kou Dist., New Taipei City, Taiwan

**Test Location:** No. 47-2, 14th Ling, Chia Pau Vil., Lin Kou Dist., New Taipei City, Taiwan

**FCC Registration /  
Designation Number:** 418586 / TW1078

**Approved by :**



**Date:** 2021/10/15

Jim Hsiang / Associate Technical Manager

This test report consists of 28 pages in total. It may be duplicated completely for legal use with the approval of the applicant. It should not be reproduced except in full, without the written approval of our laboratory. The test results in the report only apply to the tested sample. The test results in this report are traceable to the national or international standards.



Prepared by : Albee Chu / Senior Specialist

Certificate #4327.01

This report is for your exclusive use. Any copying or replication of this report to or for any other person or entity, or use of our name or trademark, is permitted only with our prior written permission. This report sets forth our findings solely with respect to the test samples identified herein. The results set forth in this report are not indicative or representative of the quality or characteristics of the lot from which a test sample was taken or any similar or identical product unless specifically and expressly noted. Our report includes all of the tests requested by you and the results thereof based upon the information that you provided to us. You have 60 days from date of issuance of this report to notify us of any material error or omission caused by our negligence, provided, however, that such notice shall be in writing and shall specifically address the issue you wish to raise. A failure to raise such issue within the prescribed time shall constitute your unqualified acceptance of the completeness of this report, the tests conducted and the correctness of the report contents. Unless specific mention, the uncertainty of measurement has been explicitly taken into account to declare the compliance or non-compliance to the specification.

## Table of Contents

<b>Release Control Record .....</b>	<b>3</b>
<b>1 Certification .....</b>	<b>4</b>
<b>2 Summary of Test Results .....</b>	<b>5</b>
2.1 Measurement Uncertainty .....	5
2.2 Supplementary Information .....	5
<b>3 General Information .....</b>	<b>6</b>
3.1 Description of EUT .....	6
3.2 Primary Clock Frequencies of Internal Source .....	6
3.3 Features of EUT .....	6
3.4 Operating Modes of EUT and Determination of Worst Case Operating Mode .....	7
3.5 Test Program Used and Operation Descriptions .....	7
3.6 Connection Diagram of EUT and Peripheral Devices .....	8
3.7 Configuration of Peripheral Devices and Cable Connections .....	9
<b>4 Test Instruments .....</b>	<b>10</b>
4.1 Conducted Emissions from Power Ports .....	10
4.2 Radiated Emissions up to 1 GHz .....	11
4.3 Radiated Emissions above 1 GHz .....	12
<b>5 Limits of Test Items .....</b>	<b>13</b>
5.1 Conducted Emissions from Power Ports .....	13
5.2 Radiated Emissions up to 1 GHz .....	13
5.3 Radiated Emissions above 1 GHz .....	13
<b>6 Test Arrangements .....</b>	<b>14</b>
6.1 Conducted Emissions from Power Ports .....	14
6.2 Radiated Emissions up to 1 GHz .....	15
6.3 Radiated Emissions above 1 GHz .....	16
<b>7 Test Results .....</b>	<b>17</b>
7.1 Conducted Emissions from Power Ports .....	17
7.2 Radiated Emissions up to 1 GHz .....	21
7.3 Radiated Emissions above 1 GHz .....	23
<b>8 Pictures of Test Arrangements .....</b>	<b>25</b>
8.1 Conducted Emissions from Power Ports .....	25
8.2 Radiated Emissions up to 1 GHz .....	26
8.3 Radiated Emissions above 1 GHz .....	27
<b>9 Information of the Testing Laboratories .....</b>	<b>28</b>



## Release Control Record

Issue No.	Description	Date Issued
FDBDBO-WTW-P21090210	Original release.	2021/10/15

## 1 Certification

**Product:** Ultra-Compact Embedded System

**Brand:** Vecow

**Test Model:** SPC-2845

**Series Model:** SPC-2XXXXXXXXXXXXXXXXXX  
("X" can be 0-9, A-Z or blank for marketing purpose)

**Sample Status:** Engineering sample

**Applicant:** Vecow Co., Ltd.

**Test Date:** 2021/9/17 ~ 2021/9/28

**Standards:** 47 CFR FCC Part 15, Subpart B, Class A  
ANSI C63.4:2014

The above equipment has been tested by **Bureau Veritas Consumer Products Services (H.K.) Ltd., Taoyuan Branch**, and found compliance with the requirement of the above standards. The test record, data evaluation & Equipment Under Test (EUT) configurations represented herein are true and accurate accounts of the measurements of the sample's EMC characteristics under the conditions specified in this report.

## 2 Summary of Test Results

The test items that the EUT needs to perform according to its interfaces and functions evaluation are as follows:

FCC Part 15 Clause	Test Item	Result/Remarks	Verdict
15.107	Conducted Emissions from Power Ports	Minimum passing Class A margin is -24.80 dB at 9.36000 MHz	Pass
15.109	Radiated Emissions up to 1 GHz	Minimum passing Class A margin is -0.48 dB at 924.01 MHz	Pass
	Radiated Emissions above 1 GHz	Minimum passing Class A margin is -12.62 dB at 1079.11 MHz	Pass

Note: Determining compliance based on the results of the compliance measurement, not taking into account measurement instrumentation uncertainty.

### 2.1 Measurement Uncertainty

Where relevant, the following measurement uncertainty levels have been estimated for tests performed on the EUT:

Measurement	Frequency	Expanded Uncertainty (k=2) ( $\pm$ )
Conducted Emissions from Power Ports	150kHz ~ 30MHz	2.94 dB
Radiated Emissions up to 1 GHz	30MHz ~ 1GHz	4.30 dB
Radiated Emissions above 1 GHz	Above 1GHz	4.48 dB

The other instruments specified are routine verified to remain within the calibrated levels, no measurement uncertainty is required to be calculated.

### 2.2 Supplementary Information

There is not any deviation from the test standards for the test method, and no modifications required for compliance.

### 3 General Information

#### 3.1 Description of EUT

Product	Ultra-Compact Embedded System
Brand	Vecow
Test Model	SPC-2845
Series Model	SPC-2XXXXXXXXXXXXXXXXXX ("X" can be 0-9, A-Z or blank for marketing purpose)
Model Difference	For marketing purpose
Sample Status	Engineering sample
Operating Software	WINDOWS 8
Power Supply Rating	DC from Adapter
Accessory Device	N/A
Data Cable Supplied	N/A

Note:

The EUT uses following adapter.

Brand	FSP
Model	FSP120-AAAN2
Input Power	100-240Vac, 1.8A, 50-60Hz
Output Power	24Vdc, 5A
Power Line	Non-shielded AC cable (1.8m, 3 Pin) DC cable (1.45m) with one ferrite core.

#### 3.2 Primary Clock Frequencies of Internal Source

The highest frequency generated or used within the EUT or on which the EUT operates or tunes is 1.6GHz, provided by Vecow Co., Ltd., for detailed internal source, please refer to the manufacturer's specifications.

#### 3.3 Features of EUT

1. The tests reported herein were performed according to the method specified by Vecow Co., Ltd., for detailed feature description, please refer to the manufacturer's specifications or user's manual.
2. The EUT configured with the following key components:

Components	Brand	Model	Specification
CPU	Intel	Atom™ E3845	1.91GHz
RAM	Kingston	DDR3L 1333 SODIMM	4GB
SSD	MEMXPRO	PT31	512GB

### 3.4 Operating Modes of EUT and Determination of Worst Case Operating Mode

1. The EUT is designed with AC power of rating 100-240Vac, 50-60Hz.  
For radiated emission evaluation, 230Vac/50Hz (for EN 50155), 120Vac/60Hz (for FCC Part 15) had been covered during the pre-test. The worst data was found at **230Vac/50Hz** and recorded in the applied test report.
2. Test modes are presented in the report as below.

Mode	Test Condition	Input Power
Conducted emission test		
1	Full System	120Vac/ 60Hz & 240Vac/ 60Hz
Radiated emission test		
1	Full System	230Vac/ 50Hz

### 3.5 Test Program Used and Operation Descriptions

- a. Turned on the power of all equipment.
- b. EUT ran a test program to enable all functions.
- c. EUT read and wrote messages from/to SSD and ext. HDDs.
- d. EUT sent and received messages to/from IP Cams (kept in a remote area) via two UTP LAN cables (10m each).
- e. EUT sent "H" messages to LCD Monitor. Then it displayed "H" messages on its screen.
- f. Steps c-e were repeated.

### 3.6 Connection Diagram of EUT and Peripheral Devices

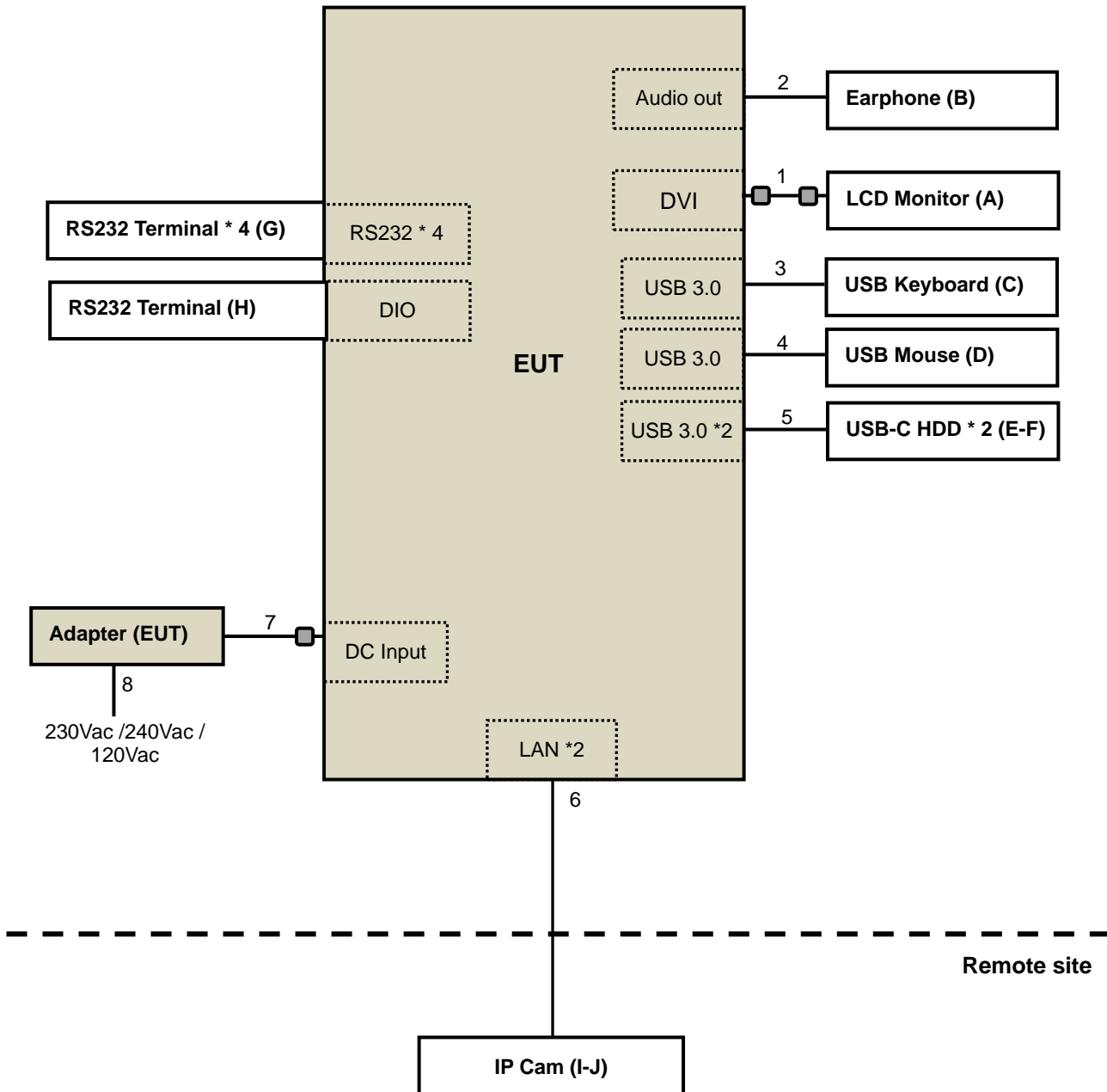



### 3.7 Configuration of Peripheral Devices and Cable Connections

ID	Product	Brand	Model No.	Serial No.	FCC ID	Remarks
A.	LCD MONITOR	DELL	U2410	CN082WXD728720CC1 0NL	FCC DoC Approved	Provided by Lab
B.	EARPHONE	PHILIPS	SBC HL150	H2010153	N/A	Provided by Lab
C.	USB Keyboard	Dell	KB216t	CN-0W33XP-LO300-7C L-1907	N/A	Provided by Lab
D.	USB Mouse	DELL	MOCZUL	CN-049TWY-PRC00-77 B-007R	N/A	Provided by Lab
E.	USB-C Hard Disk	G-DRIVE	0G04878	620XLYKW	FCC DoC Approved	Provided by Lab
F.	USB-C Hard Disk	G-DRIVE	0G04878	620XHJHW	FCC DoC Approved	Provided by Lab
G.	RS232 Terminal* 4	NA	NA	NA	NA	Supplied by client
H.	RS232 Terminal	NA	NA	NA	NA	Supplied by client
I.	IP Cam	3MP	MBL030A-ORZ0310	T52671342	N/A	Supplied by client
J.	IP Cam	3MP	MBL030A-ORZ0310	T52671344	N/A	Supplied by client

Note:

1. All power cords of the above support units are non-shielded (1.8m).
2. Items I-J acted as communication partners to transfer data.

ID	Cable Descriptions	Qty.	Length (m)	Shielding (Yes/No)	Cores (Qty.)	Remarks
1.	DVI cable	1	1.8	Y	2	Provided by Lab
2.	Audio cable	1	1.2	N	0	Provided by Lab
3.	USB cable	1	1.8	Y	0	Provided by Lab
4.	USB cable	1	1.8	Y	0	Provided by Lab
5.	USB cable	2	1.0	Y	0	Provided by Lab
6.	LAN cable	2	10	Y	0	Provided by Lab (RJ45, Cat.5e)
7.	DC power cable	1	1.45	N	1	Supplied by client
8.	AC power cable	1	1.8	N	0	Provided by Lab

Note: The core(s) is(are) originally attached to the cable(s).

## 4 Test Instruments

The calibration interval of the all test instruments are 12 months and the calibrations are traceable to NML/ROC and NIST/USA.

### 4.1 Conducted Emissions from Power Ports

Description & Manufacturer	Model No.	Serial No.	Calibrated Date	Calibrated Until
Test Receiver R&S	ESR3	102413	2021/2/8	2022/2/7
LISN R&S	ESH2-Z5	100104	2020/12/18	2021/12/17
LISN SCHWARZBECK	NNLK8129	8129229	2021/5/20	2022/5/19
DC LISN SCHWARZBECK	NNLK 8121	8121-808	2021/4/18	2022/4/17
LISN SCHWARZBECK	NNLK 8121	8121-731	2021/4/28	2022/4/27
LISN R & S	ESH3-Z5	847265/023	2020/11/11	2021/11/10
LISN R&S	ENV216	101196	2021/4/26	2022/4/25
LISN R&S	ESH3-Z6	844950/018	2021/7/25	2022/7/24
DC LISN R&S	ESH3-Z6	100219	2021/7/25	2022/7/24
RF Coaxial Cable Commate	5D-FB	Cable-CO9-01	2021/8/13	2022/8/12
Attenuator STI	STI02-2200-10	NO.2	2021/8/13	2022/8/12
50 ohms Terminator LYNICS	0900510	E1-01-299	2021/1/27	2022/1/26
Isolation Transformer Erika Fiedler	D-65396	017	2021/9/9	2022/9/8
Software BVADT	Cond_V7.3.7.4	NA	NA	NA

- Note: 1. The test was performed in Linkou Conduction 09.  
 2. The VCCI Site Registration No. C-11312.  
 3. Tested Date: 2021/9/28

#### 4.2 Radiated Emissions up to 1 GHz

Description & Manufacturer	Model No.	Serial No.	Calibrated Date	Calibrated Until
TEST RECEIVER R&S	ESCS 30	100292	2021/9/1	2022/8/31
Bi-log Broadband Antenna Schwarzbeck	VULB9168	9168-303	2020/11/5	2021/11/4
Pre_Amplifier HP	8447D	2944A08119	2021/2/18	2022/2/17
RF Coaxial Cable Pacific	8D-FB	Cable-ST2-01	2020/10/23	2021/10/22
Attenuator Mini-Circuits	UNAT-5+	PAD-ST2-01	2020/10/23	2021/10/22
ADT. Turn Table	TT100	0205	NA	NA
ADT. Tower	AT100	0205	NA	NA
Software BVADT	Radiated_V7.6.15.9.5	NA	NA	NA

- Note:
1. The test was performed in Linkou Open Site2 , The test site validated date: 2021/07/30(NSA)
  2. The VCCI Site Registration No. R-10237.
  3. Tested Date: 2021/9/24

### 4.3 Radiated Emissions above 1 GHz

Description & Manufacturer	Model No.	Serial No.	Calibrated Date	Calibrated Until
Spectrum Analyzer Agilent	E4446A	MY51100009	2021/6/29	2022/6/28
Spectrum Keysight	N9020B	MY60110438	2020/12/2	2021/12/1
Test Receiver Agilent	N9038A	MY51210137	2021/6/16	2022/6/15
Pre-amplifier HP	8449B	3008A01292	2021/2/19	2022/2/18
Pre_Amplifier EMCI	EMC0126545	980076	2021/2/19	2022/2/18
HORN Antenna ETS	3117-PA	00215857	2020/11/22	2021/11/21
Antenna(Horn) EMCO	3115	6714	2020/11/22	2021/11/21
Pre_Amplifier MITEQ	AMF-6F-260400-33-8P	892164	2021/2/19	2022/2/18
Pre_Amplifier EMCI	EMC184045B	980235	2021/2/19	2022/2/18
Broadband Horn Antenna Schwarzbeck	BBHA 9170	212	2020/11/22	2021/11/21
RF Coaxial Cable Rosnol	K1K50-UP0279-K1K50-3000	Cable-CH10(3m)-04	2021/7/8	2022/7/7
RF Coaxial Cable WOKEN	WC01	Cable-CH10-03	2021/7/8	2022/7/7
Attenuator Mini-Circuits	BW-N4W5+	PAD-CH10-02	2021/7/8	2022/7/7
Attenuator Mini-Circuits	BW-K3-2W44+	PAD-CH7-03	2021/7/8	2022/7/7
BandPass Filter MICRO-TRONICS	BRM17690	005	2021/5/28	2022/5/27
Notch filter MICRO-TRONICS	BRC50703-01	010	2021/5/28	2022/5/27
Turn Table & Tower Max Full	MF7802	MF780208216	NA	NA
Software BVADT	Radiated_V8.7.08	NA	NA	NA

- Note:
1. The test was performed in Linkou 966 Chamber3(CH10).
  2. The VCCI Site Registration No. G-10427
  3. Tested Date: 2021/9/17

## 5 Limits of Test Items

### 5.1 Conducted Emissions from Power Ports

Frequency (MHz)	Class A (dBuV)		Class B (dBuV)	
	Quasi-peak	Average	Quasi-peak	Average
0.15 - 0.5	79	66	66 - 56	56 - 46
0.5 - 5.0	73	60	56	46
5.0 - 30.0	73	60	60	50

Notes: 1. The lower limit shall apply at the transition frequencies.  
 2. The limit decreases linearly with the logarithm of the frequency in the range of 0.15 to 0.50 MHz.

### 5.2 Radiated Emissions up to 1 GHz

Radiated Emissions Limits at 10 meters (dB $\mu$ V/m)				
Frequencies (MHz)	FCC Part 15B, Class A	FCC Part 15B, Class B	CISPR 22, Class A	CISPR 22, Class B
30-88	39	29.5	40	30
88-216	43.5	33.1		
216-230	46.4	35.6		
230-960			47	37
960-1000	49.5	43.5		

Radiated Emissions Limits at 3 meters (dB $\mu$ V/m)				
Frequencies (MHz)	FCC Part 15B, Class A	FCC Part 15B, Class B	CISPR 22, Class A	CISPR 22, Class B
30-88	49.5	40	50.5	40.5
88-216	54	43.5		
216-230	56.9	46		
230-960			57.5	47.5
960-1000	60	54		

Notes: 1. The lower limit shall apply at the transition frequencies.

### 5.3 Radiated Emissions above 1 GHz

Frequency Range (For unintentional radiators)

Highest frequency generated or used in the device or on which the device operates or tunes (MHz)	Upper frequency of measurement range (MHz)
Below 1.705	30
1.705-108	1000
108-500	2000
500-1000	5000
Above 1000	5th harmonic of the highest frequency or 40GHz, whichever is lower

Radiated Emissions Limits at 3 meters (dB $\mu$ V/m)		
Frequency range	Class A	Class B
Above 1GHz	Avg: 60 Peak: 80	Avg: 54 Peak: 74

Notes: 1. These limit levels apply for a measurement distance of 3 m. If using a different measurement distance, the measured levels shall be extrapolated to the 3 m limit distance using a factor of 20 dB per decade of distance. The measurement distance shall place the measurement antenna in the far field of the ITE or digital apparatus under test.

## 6 Test Arrangements

### 6.1 Conducted Emissions from Power Ports

- For the table-top EUT is placed on a 0.8 meter to the top of rotating table; for the the floor standing EUT shall be insulated (by insulation of 12 mm) from the horizontal reference ground plane. The EUT is placed 0.4 meters from the conducting wall of the shielded room with EUT being connected to the power mains through a line impedance stabilization network (LISN). Other support units are connected to the power mains through another LISN. They provide coupling impedance for the measuring instrument.
- Both lines of the power mains connected to the EUT were checked for maximum conducted interference.
- The test results of conducted emissions at mains ports are recorded of six worst margins for quasi-peak (mandatory) [and average (if necessary)] values against the limits at frequencies of interest unless the margin is 20 dB or greater.

Note: The resolution bandwidth and video bandwidth of test receiver is 9kHz for quasi-peak detection (QP) and average detection (AV) at frequency 0.15MHz-30MHz.

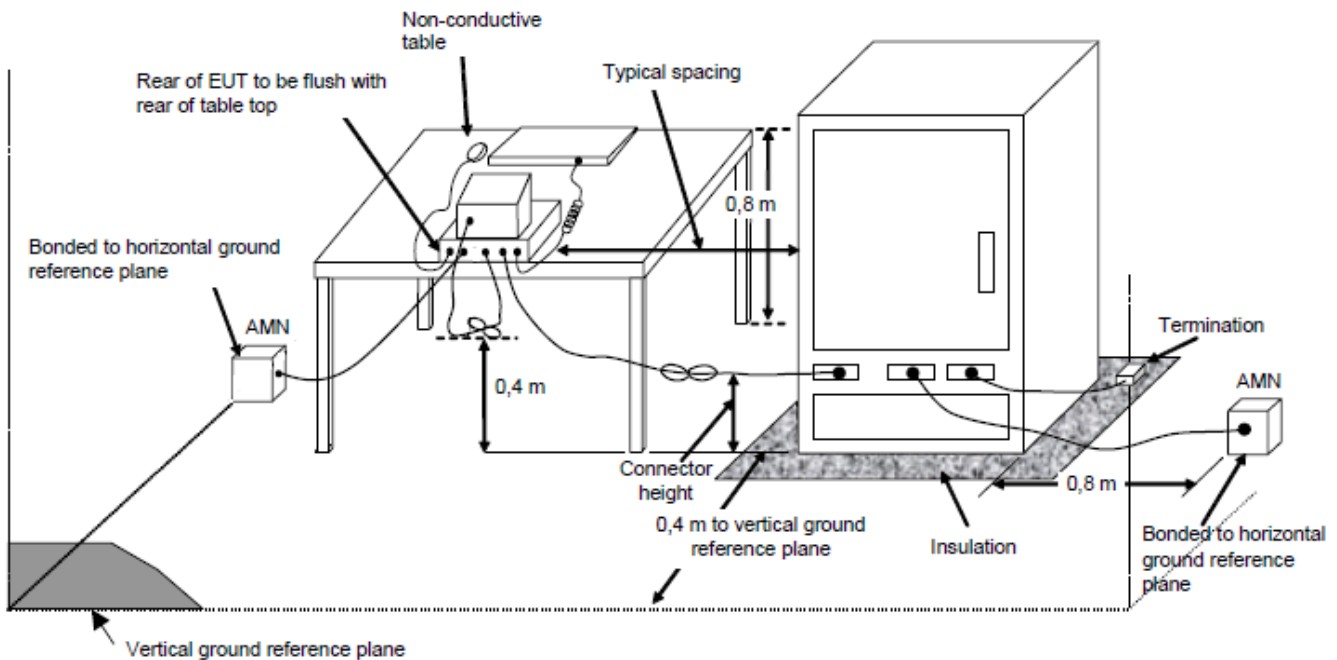

For the actual test configuration, please refer to the related Item – Photographs of the Test Configuration.

## 6.2 Radiated Emissions up to 1 GHz

- For the table-top EUT is placed on a 0.8 meter to the top of rotating table; for the the floor standing EUT shall be insulated (by insulation of 12 mm) from the horizontal reference ground plane. The rotating table is rotated 360 degrees to determine the position of the highest radiation. If the equipment requires a dedicated ground connection, this shall be provided and bonded to the RGP.
- The EUT was set 10 meters away from the interference-receiving antenna, which was mounted on the top of a variable-height antenna tower.
- The antenna is a broadband antenna, and its height is varied from one meter to four meters above the ground to determine the maximum value of the field strength. Both horizontal and vertical polarizations of the antenna are set to make the measurement.
- For each suspected emission, the EUT was arranged to its worst case and then the antenna was tuned to heights from 1 meter to 4 meters and the rotatable table was turned from 0 degrees to 360 degrees to find the maximum reading.
- The test-receiver system was set to quasi-peak detect function and specified bandwidth with maximum hold mode when the test frequency is up to 1 GHz.

Note: The resolution bandwidth and video bandwidth of test receiver/spectrum analyzer is 120kHz for quasi-peak detection (QP) at frequency up to 1GHz.

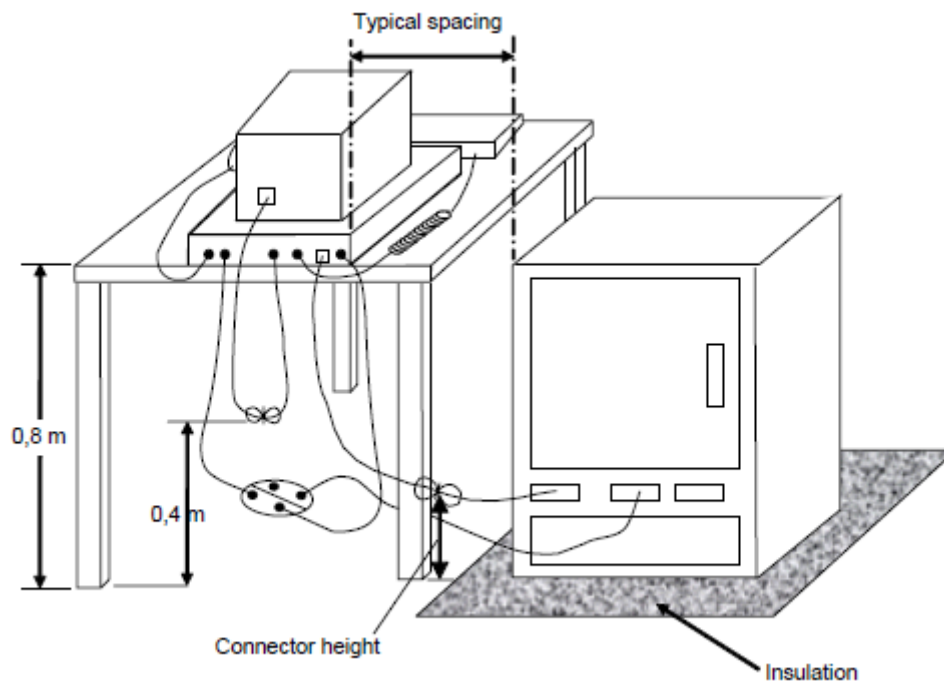

For the actual test configuration, please refer to the related Item – Photographs of the Test Configuration.

### 6.3 Radiated Emissions above 1 GHz

- For the table-top EUT is placed on a 0.8 meter to the top of rotating table; for the the floor standing EUT shall be insulated (by insulation of 12 mm) from the horizontal reference ground plane. The rotating table is rotated 360 degrees to determine the position of the highest radiation. If the equipment requires a dedicated ground connection, this shall be provided and bonded to the RGP.
- The EUT was set  $d = 3$  meters away from the interference-receiving antenna, which was mounted on the top of a variable-height antenna tower.
- The height of antenna can be varied from one meter to four meters, the height of adjustment depends on the EUT height and the antenna 3dB beamwidth both, to detect the maximum value of the field strength. Both horizontal and vertical polarizations of the antenna are set to make the measurement.
- For each suspected emission, the EUT was arranged to its worst case and then the antenna was tuned to heights and the rotatable table was turned from 0 degrees to 360 degrees to find the maximum reading.
- The spectrum analyzer system was set to peak and average detects function and specified bandwidth with maximum hold mode when the test frequency is above 1 GHz.

Note: The resolution bandwidth of test receiver/spectrum analyzer is 1MHz and video bandwidth is 3MHz for Peak detection (PK) at frequency above 1GHz. The resolution bandwidth of test receiver/spectrum analyzer is 1 MHz for Average

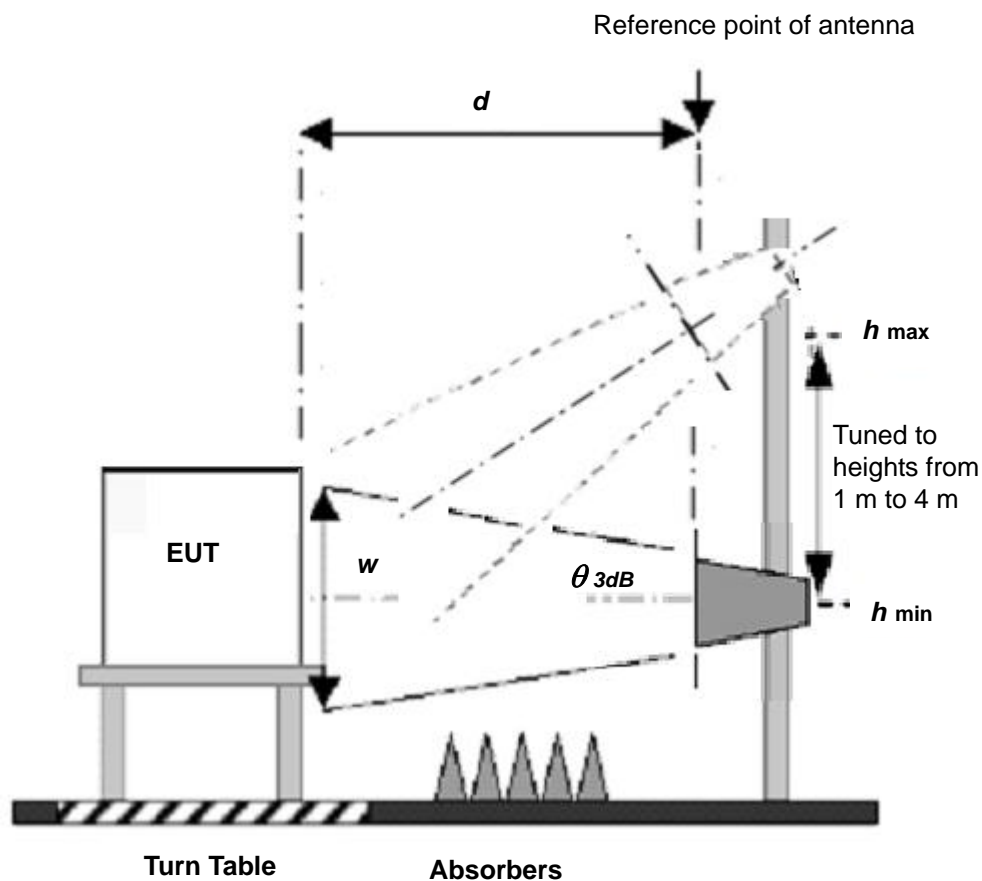

detection (AV) at frequency above 1GHz.

For the actual test configuration, please refer to the related item – Photographs of the Test Configuration.



## 7 Test Results

### 7.1 Conducted Emissions from Power Ports

#### Mode 1

Frequency Range	150kHz ~ 30MHz	Detector Function & Resolution Bandwidth	Quasi-Peak (QP) / Average (AV), 9kHz
Input Power	120Vac, 60Hz	Environmental Conditions	25 °C, 72% RH
Tested by	Ed. Lin		

#### Phase Of Power : Line (L)

No	Frequency (MHz)	Correction Factor (dB)	Reading Value (dBuV)		Emission Level (dBuV)		Limit (dBuV)		Margin (dB)	
			Q.P.	AV.	Q.P.	AV.	Q.P.	AV.	Q.P.	AV.
1	0.15000	10.06	21.71	10.02	31.77	20.08	79.00	66.00	-47.23	-45.92
2	1.98800	10.21	13.47	3.67	23.68	13.88	73.00	60.00	-49.32	-46.12
3	3.42000	10.30	13.07	0.11	23.37	10.41	73.00	60.00	-49.63	-49.59
4	9.32000	10.58	28.77	19.32	39.35	29.90	73.00	60.00	-33.65	-30.10
5	17.32800	10.95	20.98	13.32	31.93	24.27	73.00	60.00	-41.07	-35.73
6	21.56800	11.07	29.38	21.17	40.45	32.24	73.00	60.00	-32.55	-27.76

#### Remarks:

1. Q.P. and AV. are abbreviations of quasi-peak and average individually.
2. The emission levels of other frequencies were very low against the limit.
3. Margin value = Emission level – Limit value
4. Correction factor = Insertion loss + Cable loss
5. Emission Level = Correction Factor + Reading Value

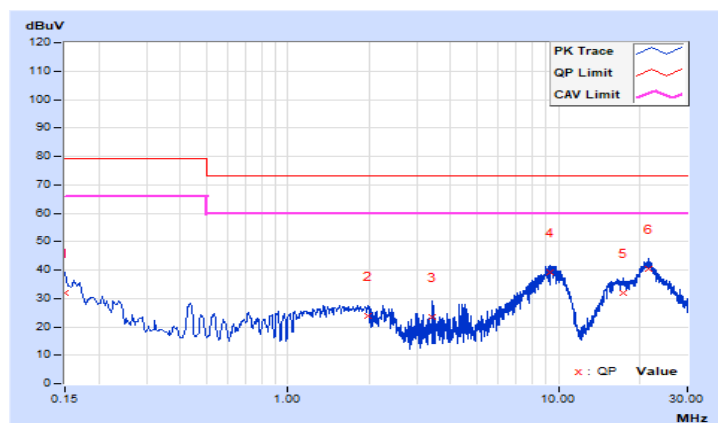

<b>Frequency Range</b>	150kHz ~ 30MHz	<b>Detector Function &amp; Resolution Bandwidth</b>	Quasi-Peak (QP) / Average (AV), 9kHz
<b>Input Power</b>	120Vac, 60Hz	<b>Environmental Conditions</b>	25 °C, 72% RH
<b>Tested by</b>	Ed. Lin		

Phase Of Power : Neutral (N)										
No	Frequency (MHz)	Correction Factor (dB)	Reading Value (dBuV)		Emission Level (dBuV)		Limit (dBuV)		Margin (dB)	
			Q.P.	AV.	Q.P.	AV.	Q.P.	AV.	Q.P.	AV.
1	0.15000	10.07	20.72	7.40	30.79	17.47	79.00	66.00	-48.21	-48.53
2	1.18400	10.16	10.32	5.60	20.48	15.76	73.00	60.00	-52.52	-44.24
3	7.14000	10.47	20.56	11.98	31.03	22.45	73.00	60.00	-41.97	-37.55
4	9.26400	10.56	29.13	19.87	39.69	30.43	73.00	60.00	-33.31	-29.57
5	17.51600	10.80	23.07	14.22	33.87	25.02	73.00	60.00	-39.13	-34.98
6	20.93600	10.83	27.85	20.72	38.68	31.55	73.00	60.00	-34.32	-28.45

**Remarks:**

1. Q.P. and AV. are abbreviations of quasi-peak and average individually.
2. The emission levels of other frequencies were very low against the limit.
3. Margin value = Emission level – Limit value
4. Correction factor = Insertion loss + Cable loss
5. Emission Level = Correction Factor + Reading Value

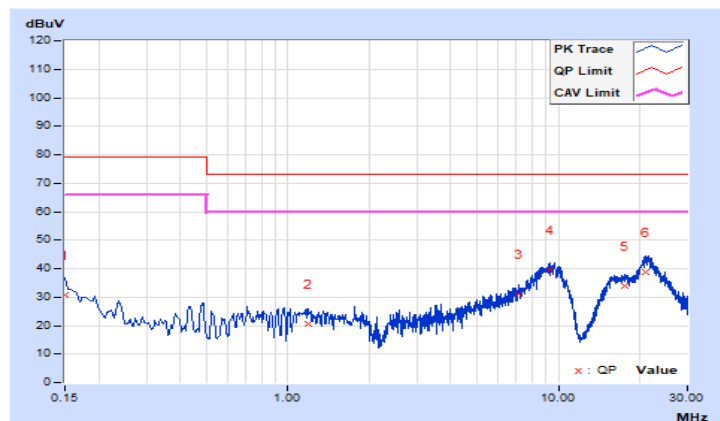

<b>Frequency Range</b>	150kHz ~ 30MHz	<b>Detector Function &amp; Resolution Bandwidth</b>	Quasi-Peak (QP) / Average (AV), 9kHz
<b>Input Power</b>	240Vac, 60Hz	<b>Environmental Conditions</b>	25 °C, 72% RH
<b>Tested by</b>	Ed. Lin		

Phase Of Power : Line (L)										
No	Frequency (MHz)	Correction Factor (dB)	Reading Value (dBuV)		Emission Level (dBuV)		Limit (dBuV)		Margin (dB)	
			Q.P.	AV.	Q.P.	AV.	Q.P.	AV.	Q.P.	AV.
1	0.15400	10.07	30.83	6.51	40.90	16.58	79.00	66.00	-38.10	-49.42
2	0.24200	10.07	20.95	13.90	31.02	23.97	79.00	66.00	-47.98	-42.03
3	7.39200	10.49	24.75	17.11	35.24	27.60	73.00	60.00	-37.76	-32.40
4	8.22000	10.53	25.19	17.88	35.72	28.41	73.00	60.00	-37.28	-31.59
<b>5</b>	<b>9.36000</b>	<b>10.58</b>	<b>32.39</b>	<b>24.62</b>	<b>42.97</b>	<b>35.20</b>	<b>73.00</b>	<b>60.00</b>	<b>-30.03</b>	<b>-24.80</b>
6	22.33200	11.07	25.89	18.51	36.96	29.58	73.00	60.00	-36.04	-30.42

**Remarks:**

1. Q.P. and AV. are abbreviations of quasi-peak and average individually.
2. The emission levels of other frequencies were very low against the limit.
3. Margin value = Emission level – Limit value
4. Correction factor = Insertion loss + Cable loss
5. Emission Level = Correction Factor + Reading Value

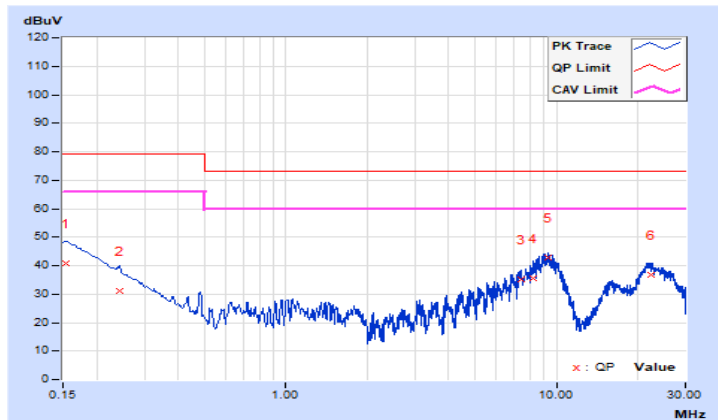

<b>Frequency Range</b>	150kHz ~ 30MHz	<b>Detector Function &amp; Resolution Bandwidth</b>	Quasi-Peak (QP) / Average (AV), 9kHz
<b>Input Power</b>	240Vac, 60Hz	<b>Environmental Conditions</b>	25 °C, 72% RH
<b>Tested by</b>	Ed. Lin		

Phase Of Power : Neutral (N)										
No	Frequency (MHz)	Correction Factor (dB)	Reading Value (dBuV)		Emission Level (dBuV)		Limit (dBuV)		Margin (dB)	
			Q.P.	AV.	Q.P.	AV.	Q.P.	AV.	Q.P.	AV.
1	0.15400	10.08	30.92	5.95	41.00	16.03	79.00	66.00	-38.00	-49.97
2	4.76800	10.37	19.75	13.35	30.12	23.72	73.00	60.00	-42.88	-36.28
3	6.47200	10.44	22.45	16.67	32.89	27.11	73.00	60.00	-40.11	-32.89
4	7.77600	10.50	24.10	14.92	34.60	25.42	73.00	60.00	-38.40	-34.58
5	9.10400	10.55	30.67	23.13	41.22	33.68	73.00	60.00	-31.78	-26.32
6	21.60000	10.80	24.82	17.10	35.62	27.90	73.00	60.00	-37.38	-32.10

**Remarks:**

1. Q.P. and AV. are abbreviations of quasi-peak and average individually.
2. The emission levels of other frequencies were very low against the limit.
3. Margin value = Emission level – Limit value
4. Correction factor = Insertion loss + Cable loss
5. Emission Level = Correction Factor + Reading Value

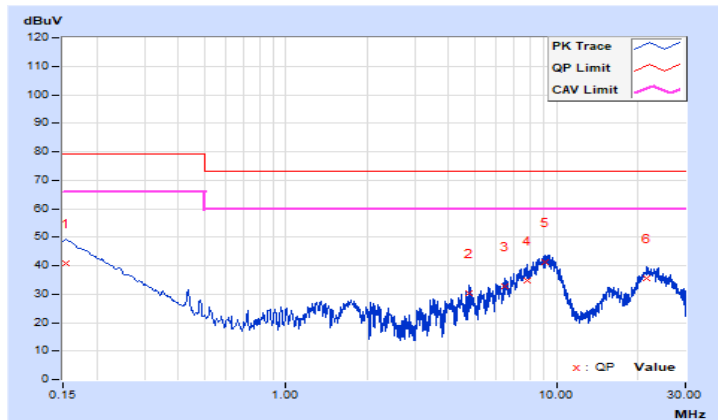

## 7.2 Radiated Emissions up to 1 GHz

### Mode 1

<b>Frequency Range</b>	30MHz ~ 1GHz	<b>Detector Function &amp; Resolution Bandwidth</b>	Quasi-Peak (QP), 120kHz
<b>Tested By</b>	Ed. Lin	<b>Environmental Conditions</b>	32 °C, 62% RH

Antenna Polarity & Test Distance : Horizontal at 10 m								
No	Frequency (MHz)	Emission Level (dBuV/m)	Limit (dBuV/m)	Margin (dB)	Antenna Height (m)	Table Angle (Degree)	Raw Value (dBuV)	Correction Factor (dB/m)
1	154.06	33.51 QP	40.00	-6.49	4.00 H	264	42.66	-9.15
2	188.82	30.68 QP	40.00	-9.32	4.00 H	163	42.52	-11.84
3	369.40	32.46 QP	47.00	-14.54	3.10 H	27	38.57	-6.11
4	616.00	44.26 QP	47.00	-2.74	1.56 H	214	44.99	-0.73
<b>5</b>	<b>924.01</b>	<b>46.52 QP</b>	<b>47.00</b>	<b>-0.48</b>	<b>1.00 H</b>	<b>173</b>	<b>40.80</b>	<b>5.72</b>
6	999.99	40.85 QP	47.00	-6.15	1.00 H	214	34.25	6.60

#### Remarks:

1. Emission Level(dBuV/m) = Raw Value(dBuV) + Correction Factor(dB/m)
2. Correction Factor(dB/m) = Antenna Factor (dB/m) + Cable Factor (dB)  
– Pre-Amplifier Factor (dB)
3. The other emission levels were very low against the limit.
4. Margin value = Emission level – Limit value

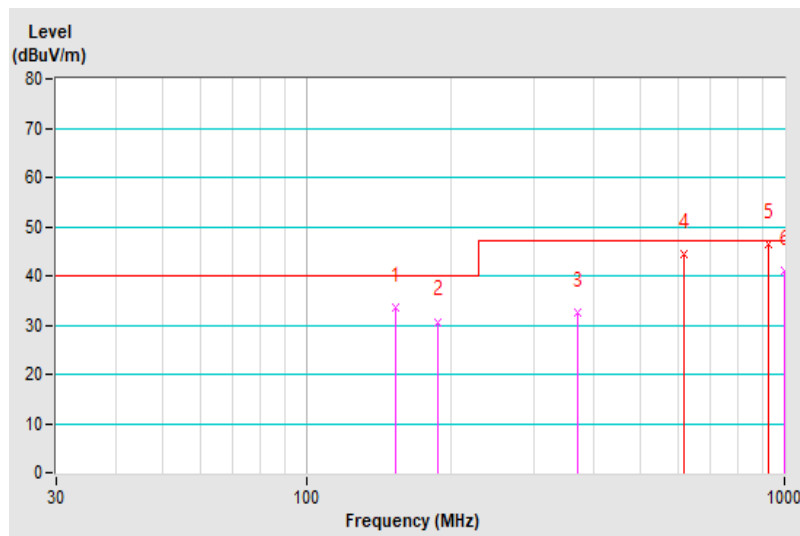

<b>Frequency Range</b>	30MHz ~ 1GHz	<b>Detector Function &amp; Resolution Bandwidth</b>	Quasi-Peak (QP), 120kHz
<b>Tested By</b>	Ed. Lin	<b>Environmental Conditions</b>	32 °C, 62% RH

Antenna Polarity & Test Distance : Vertical at 10 m								
No	Frequency (MHz)	Emission Level (dBuV/m)	Limit (dBuV/m)	Margin (dB)	Antenna Height (m)	Table Angle (Degree)	Raw Value (dBuV)	Correction Factor (dB/m)
1	32.61	30.46 QP	40.00	-9.54	1.00 V	172	41.86	-11.40
2	87.56	30.19 QP	40.00	-9.81	1.65 V	3	46.05	-15.86
3	125.03	32.10 QP	40.00	-7.90	1.00 V	210	43.28	-11.18
4	154.06	32.17 QP	40.00	-7.83	1.00 V	152	41.32	-9.15
5	212.62	31.61 QP	40.00	-8.39	1.00 V	256	43.72	-12.11
6	368.12	37.08 QP	47.00	-9.92	1.00 V	287	43.23	-6.15
7	924.00	44.68 QP	47.00	-2.32	2.20 V	85	38.96	5.72

**Remarks:**

1. Emission Level(dBuV/m) = Raw Value(dBuV) + Correction Factor(dB/m)
2. Correction Factor(dB/m) = Antenna Factor (dB/m) + Cable Factor (dB)  
– Pre-Amplifier Factor (dB)
3. The other emission levels were very low against the limit.
4. Margin value = Emission level – Limit value

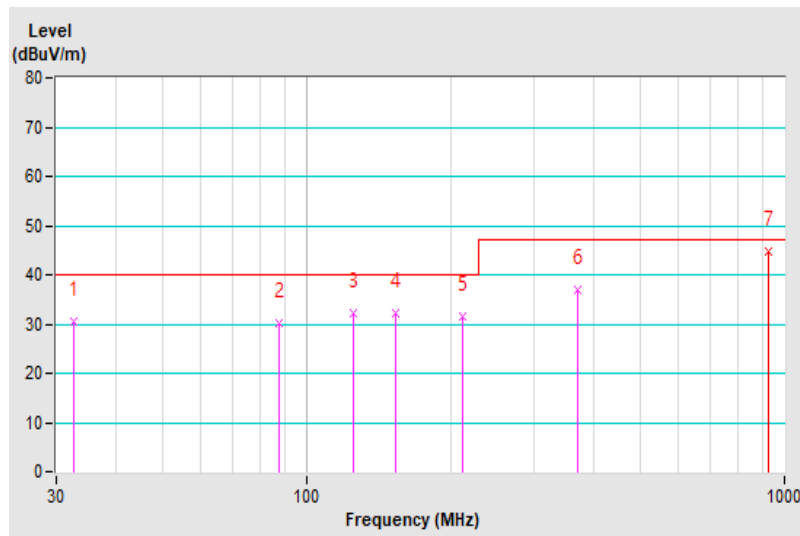

### 7.3 Radiated Emissions above 1 GHz

#### Mode 1

<b>Frequency Range</b>	1GHz ~ 9.55GHz	<b>Detector Function &amp; Resolution Bandwidth</b>	Peak (PK) / Average (AV), 1MHz
<b>Tested By</b>	Paul Chen	<b>Environmental Conditions</b>	30 °C, 59% RH

Antenna Polarity & Test Distance : Horizontal at 3 m								
No	Frequency (MHz)	Emission Level (dBuV/m)	Limit (dBuV/m)	Margin (dB)	Antenna Height (m)	Table Angle (Degree)	Raw Value (dBuV)	Correction Factor (dB/m)
1	1079.11	59.93 PK	80.00	-20.07	1.23 H	134	83.02	-23.09
<b>2</b>	<b>1079.11</b>	<b>47.38 AV</b>	<b>60.00</b>	<b>-12.62</b>	<b>1.23 H</b>	<b>134</b>	<b>70.47</b>	<b>-23.09</b>
3	1789.01	51.12 PK	80.00	-28.88	2.45 H	360	72.23	-21.11
4	1789.01	29.71 AV	60.00	-30.29	2.45 H	360	50.82	-21.11
5	2392.26	59.43 PK	80.00	-20.57	1.00 H	137	78.20	-18.77
6	2392.26	34.45 AV	60.00	-25.55	1.00 H	137	53.22	-18.77
7	4979.05	55.38 PK	80.00	-24.62	1.39 H	360	69.20	-13.82
8	4979.05	37.21 AV	60.00	-22.79	1.39 H	360	51.03	-13.82

#### Remarks:

1. Emission Level(dBuV/m) = Raw Value(dBuV) + Correction Factor(dB/m)
2. Correction Factor(dB/m) = Antenna Factor (dB/m) + Cable Factor (dB) – Pre-Amplifier Factor (dB)
3. The other emission levels were very low against the limit.
4. Margin value = Emission level – Limit value

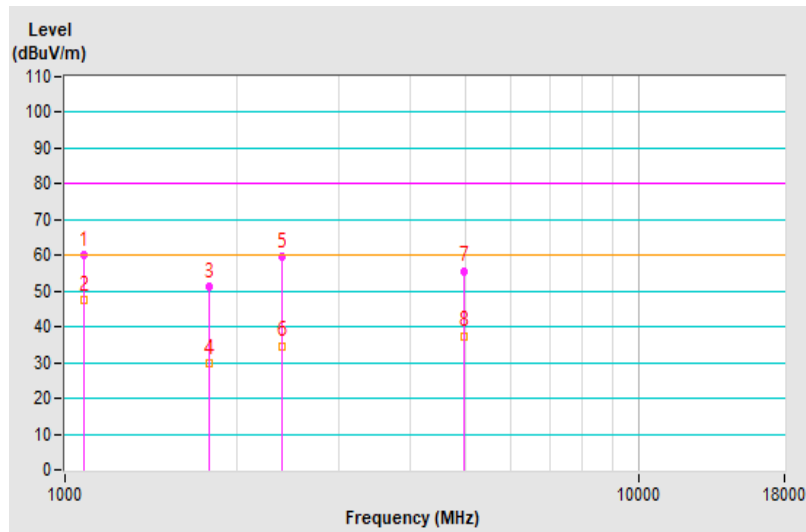

<b>Frequency Range</b>	1GHz ~ 9.55GHz	<b>Detector Function &amp; Resolution Bandwidth</b>	Peak (PK) / Average (AV), 1MHz
<b>Tested By</b>	Paul Chen	<b>Environmental Conditions</b>	30 °C, 59% RH

Antenna Polarity & Test Distance : Vertical at 3 m								
No	Frequency (MHz)	Emission Level (dBuV/m)	Limit (dBuV/m)	Margin (dB)	Antenna Height (m)	Table Angle (Degree)	Raw Value (dBuV)	Correction Factor (dB/m)
1	1079.19	59.09 PK	80.00	-20.91	2.15 V	128	82.18	-23.09
2	1079.19	45.71 AV	60.00	-14.29	2.15 V	128	68.80	-23.09
3	2199.00	58.11 PK	80.00	-21.89	1.87 V	84	77.95	-19.84
4	2199.00	33.03 AV	60.00	-26.97	1.87 V	84	52.87	-19.84
5	2378.79	56.95 PK	80.00	-23.05	1.60 V	86	75.77	-18.82
6	2378.79	32.67 AV	60.00	-27.33	1.60 V	86	51.49	-18.82
7	4999.39	54.52 PK	80.00	-25.48	2.53 V	1	68.35	-13.83
8	4999.39	35.14 AV	60.00	-24.86	2.53 V	1	48.97	-13.83

**Remarks:**

1. Emission Level(dBuV/m) = Raw Value(dBuV) + Correction Factor(dB/m)
2. Correction Factor(dB/m) = Antenna Factor (dB/m) + Cable Factor (dB) – Pre-Amplifier Factor (dB)
3. The other emission levels were very low against the limit.
4. Margin value = Emission level – Limit value

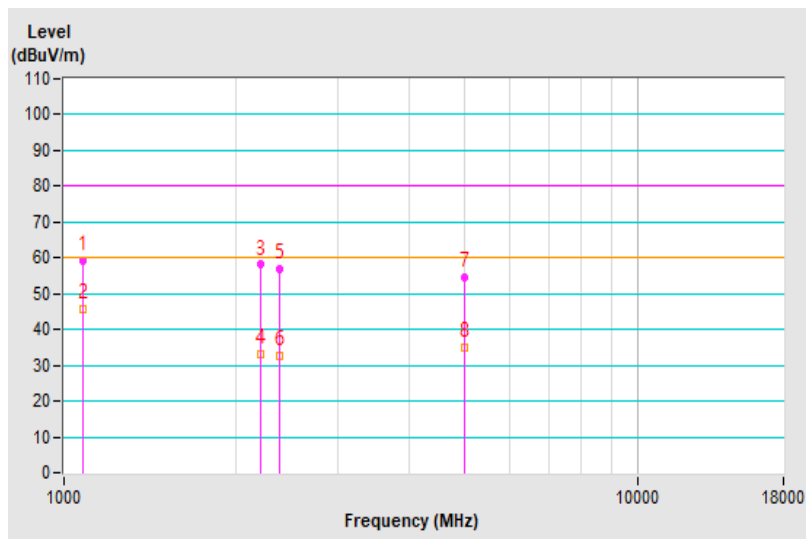



## 8 Pictures of Test Arrangements

### 8.1 Conducted Emissions from Power Ports

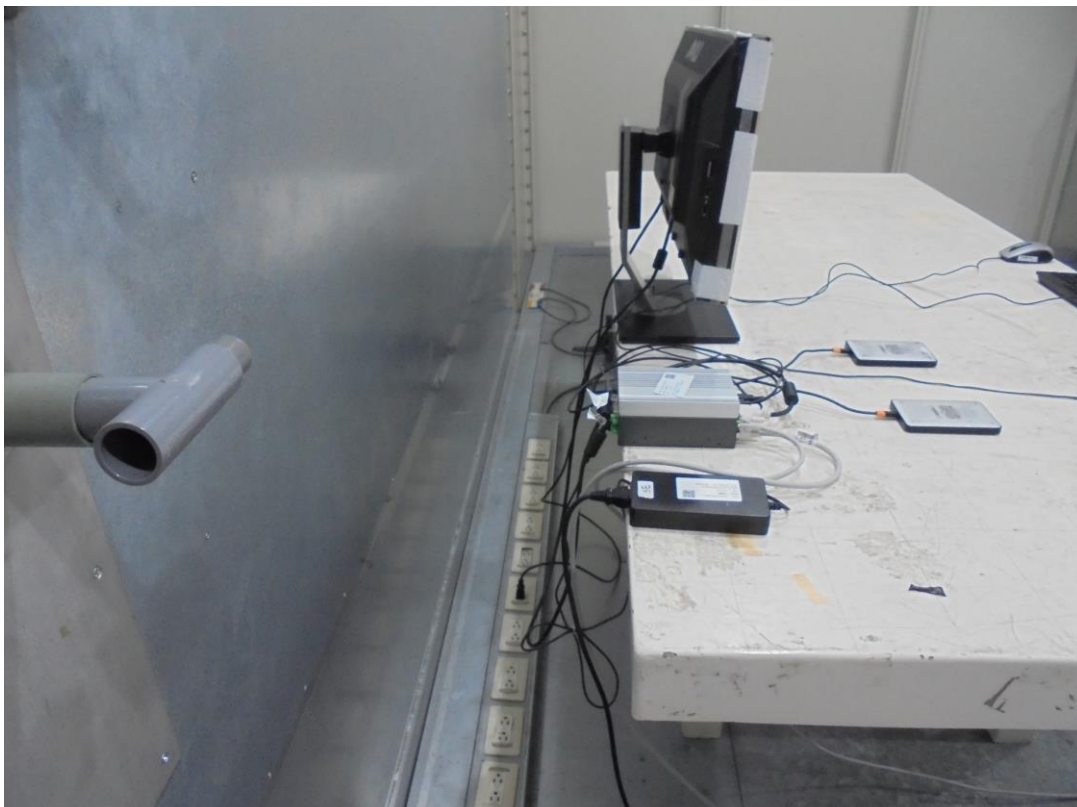

## 8.2 Radiated Emissions up to 1 GHz



### 8.3 Radiated Emissions above 1 GHz

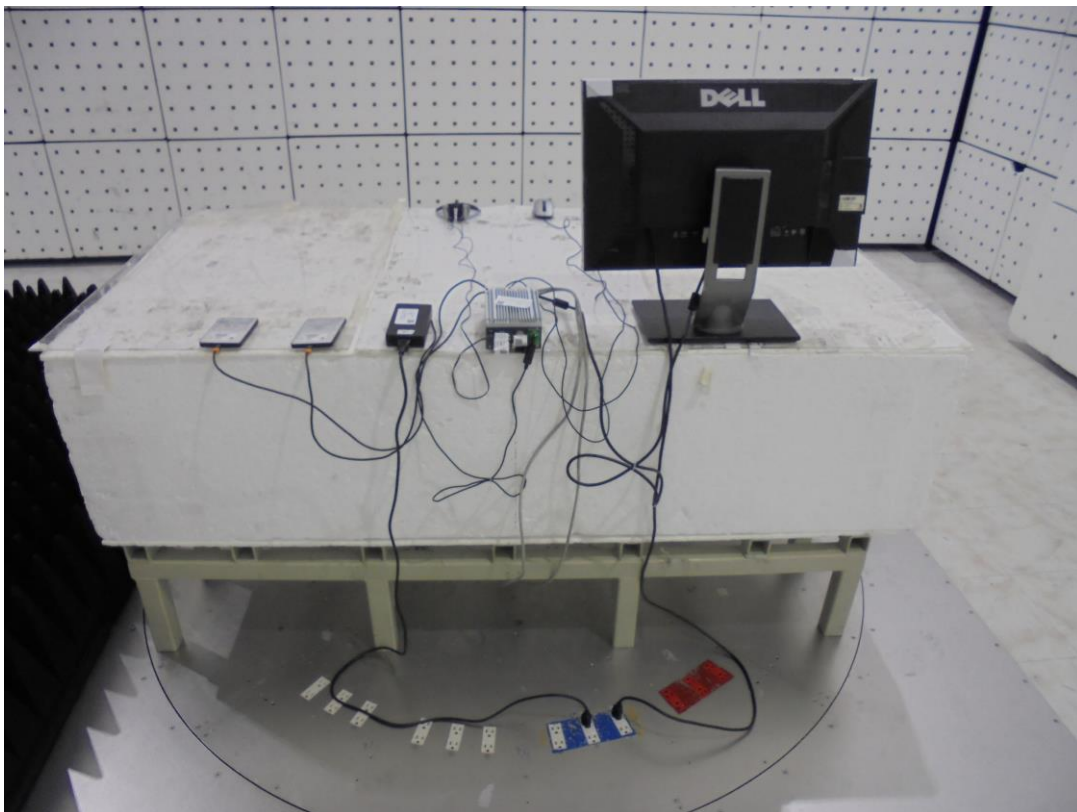



## 9 Information of the Testing Laboratories

We, Bureau Veritas Consumer Products Services (H.K.) Ltd., Taoyuan Branch, were founded in 1988 to provide our best service in EMC, Radio, Telecom and Safety consultation. Our laboratories are accredited and approved according to ISO/IEC 17025.

If you have any comments, please feel free to contact us at the following:

**Lin Kou EMC/RF Lab**

Tel: 886-2-26052180

Fax: 886-2-26051924

**Hsin Chu EMC/RF/Telecom Lab**

Tel: 886-3-6668565

Fax: 886-3-6668323

**Hwa Ya EMC/RF/Safety Lab**

Tel: 886-3-3183232

Fax: 886-3-3270892

**Email:** [service.adt@tw.bureauveritas.com](mailto:service.adt@tw.bureauveritas.com)

**Web Site:** [www.bureauveritas-adt.com](http://www.bureauveritas-adt.com)

The address and road map of all our labs can be found in our web site also.

--- END ---